

English.....	2
Svenska.....	15
Norsk.....	28
Dansk.....	41
Suomi.....	54
Deutsch.....	68
Netherlands.....	81
Français.....	95
Italiano.....	110
Español.....	124
Português.....	137
Ελληνικά.....	150
Polski.....	164
Eesti.....	177
Lietuviškai.....	189
Latviski.....	204
Русский.....	218

Specification

Reading	0,005 mm
Accuracy	± 0,005 mm
Power	240 V
Temperature operation	0 – 45 °C
Temperature storage	-30 – 70 °C
Humidity max	90 %

CE Low voltage directive 73/23/EEC samt 89/336/EEC.

Warning / Maintenance

- Protect scales and Display from water, oil, metal chips, dust etc.
- Do not use in atmosphere with flammable gases and exposed in direct sunlight.
- High voltage and strong magnetism can damage the equipment.
- Turn off the power if the device not will be used for a long time.
- The Display have a charged lithium battery for save data. If the device not have been used for a long time, the battery can have been damaged.
- Keep the equipment clean. Clean with clean and soft rag, dipped in alcohol or similar cleaning fluid.

Installation

- The length of the scales have to be longer than machine movement.
- Check the scale are turned correct so reading value will be increasing in correct direction.





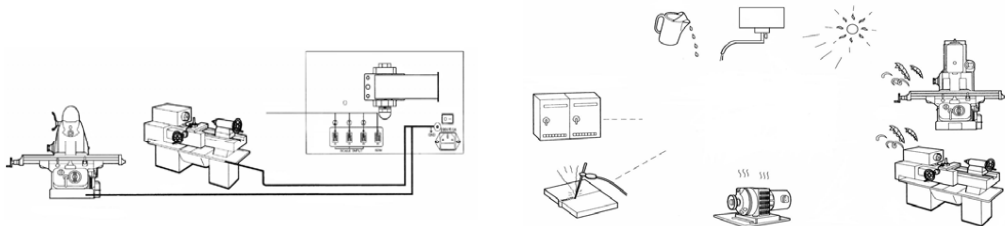









See coordinate system page 4.

- Parallelism between the scales and machine guide rails is not more than 0,15 mm.
- Parallelism between the sides of the scales and the reading head is not more than 0,1 mm
- The span between the scale surface and the reading head 0,8 – 1,0 mm.
- The scale and reading head should be assembled in center of machine movement.
- If the scale are longer than 1000 mm, mounting pads should be installed to ensure the parallelism.
- The open side of scales should be installed to avoid contact from water, oil, cutting chips etc. The dustproof cover must have minimum distance to the scale 0,5 mm.
- Signal wires and power cable must be proper fixed to avoid damage and hindered operation
- The Display must be installed with a separate ground wire.









Display

Display buttons

	Page
	Select axis. 4
Xo Yo Zo	Zero set axis. 5
	Halve display value 6
	Toggle between absolute and incremental value 5
	Store X Y Z positions 5
	Toggle between metric and imperial.
	Oblique line function 10
	Arc cutting function 7, 8, 9
	Circle holes function 11
	Finding zero automatically 5
	Stroll up and down to select.
	Inner cavity function 13
	Bevel function 12
	Tool compensating function 14
	Enter

Calculator

	Enter calculator function
	Delete last input data
	Inverse Trigonometric function
	Trigonometric function key
	Square root key
	Add Decrease Multiple Divide

Coordinate system

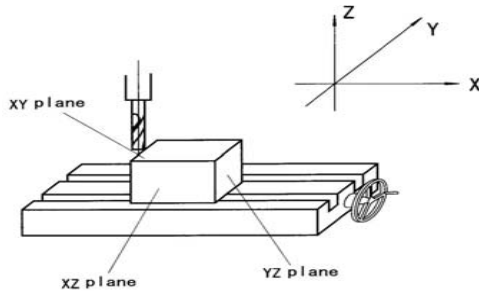

Setting

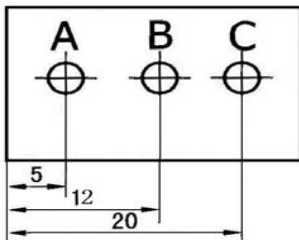

Example

Align the tool to A.
Zero X-axis. Press **Xo**

Press **X** Press **5**. Press **ENT**

Move machine table to B. The display shows *12.000*

Move machine table to C. The display shows *20.000*

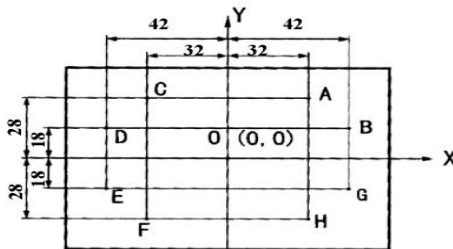





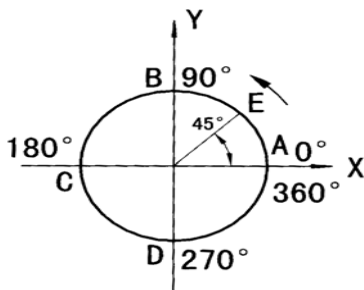









- O: (0, 0)
- A: (32, 28)
- B: (42, 18)
- C: (-32, 28)
- D: (-42, 18)
- E: (-42, -18)
- F: (-32, -28)
- G: (42, -18)
- H: (32, -28)

Arc direction



- A to B = 0° to 90°
- B to A = 90° to 0°
- B to C = 90° to 180°
- C to B = 180° to 90°
- C to D = 180° to 270°
- D to C = 270° to 180°
- D to A = 270° to 360°

- Start** Press **1/0** button on backside of display
- Zero set** The scales value can be zero in any position. Press **Xo Yo** or **Zo**.
- Return** Terminate any function press same function button again.
- Preset value** Select any axis. Example X-axis. Press .
Press selected value with figure buttons. Confirm press .
- Absolute/Incremental value** Press  or   for toggle between absolute and incremental value.
- Store coordinate positions** 200 coordinate positions can be stored. **SDM** Second Data Memory
Press  or   for toggle between absolute, incremental or SDM1, SDM2 ...SDM200.
- Store an coordinate position** Press . Select a number with figure buttons. Example 50. Adjust machine table in selected position. Press **Xo Yo** or **Zo**
Confirm . The position is stored as *SDM50*
- Search a stored Coordinate position** Press  Press **50**. Confirm 
The display shows *SDM50* position.
- Axis compensation setting** Linear error compensating is to rectify a system error.
For instance, machine table movement are not parallel to the scale.
This can be checked with gage blocks or similar.
An error can be compensated with a coefficient.
Example. Machine table movement is 400,000 mm. The display shows 399,990.
The error is 0,010 mm in 400 mm = 0,030 mm/m.
Coefficient = (Measured value – Display value) / (Measured value/1000)
Press  Press  Press coefficient **0,03**. Press .

Mid point calculation

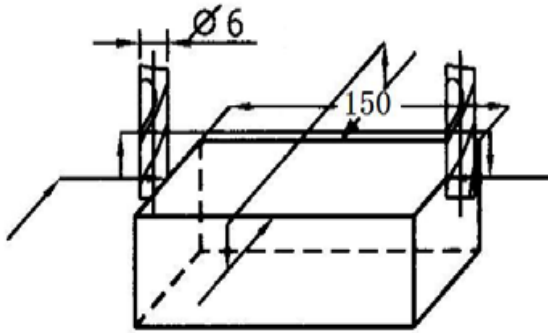

Example

Move machine table to contact one side

Zero set X-axis. X-Display shows 0.000

Move machine table to contact opposite

side X-Display shows 156.000

Press **X** $\frac{1}{2}$ Display shows 78.000

Mid point is when X-Display shows 0.000

Automatic find zero

When machine table has been moved in case such as outage or stop in operation, it can be difficult to find reference zero. Memorizing and finding the reference point must be in absolute system.

Zero set axis. Press **X0 Yo.**

Press **ABS/INC** or **↑** **↓** for absolute system.

Select Find Zero function. Press **RI** **↓** **ENT**

To find reference point of X axis. Press **X**

In the example is distance $A - 0 = 104$ mm.

Move table until X-axis shows 0.

Find Y-axis referencepoint in same way. Press **Y**

In the example is distance $B - 0 = 20$ mm.

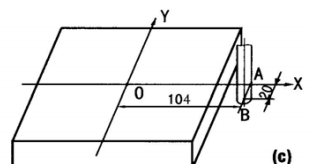
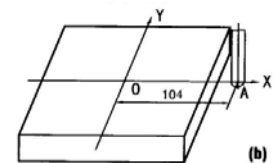
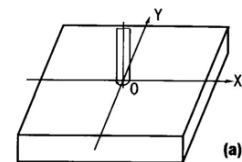

Arc cutting function

Example 1

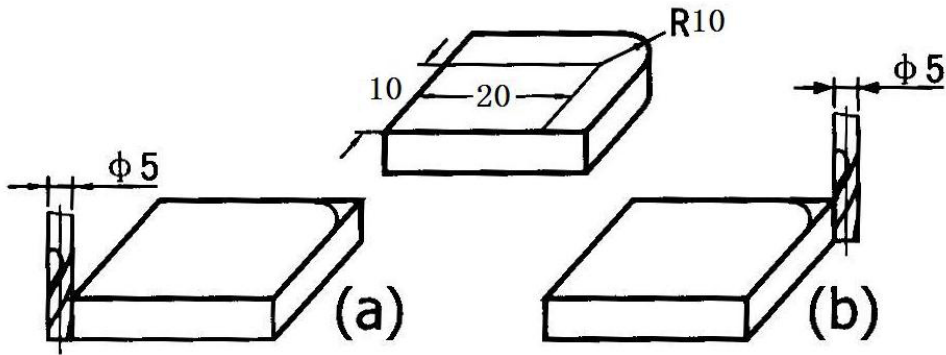

Mount workpiece and tool setting. Zero set each axis. Press **Xo Yo Zo**.

Select Arc function. Press . ARC shows on the display.

Select plane XY, XZ or YZ. See page 4. Press with

Example 1 above is plane XY. Confirm with Press for next step.

Input arc center CT Distance from centre of tool position to centre of arc.

CT in (a) X=22,5 Y=12,5

Press **22,5** . Press **12,5** . Press for next step.

CT in (b) X=12,5 Y=12,5

Press **12,5** . Press **12,5** . Press for next step.

Input Arc Radius. RADIUS

Radius is 10 mm. Press **10** . Press for next step.

Input diameter of tool. TL DIA.

Diameter is 5 mm. Press **5** . Press for next step.

Input max cutting MAX CUT.

Select cutting depth for each cut. For instance 1 mm. Press **1** . Press for next step.

Input starting angle ST ANG. See page 4.

Given anti clockwise. 3 o'clock = 0° 12 o'clock = 90° 9 o'clock = 180° 6 o'clock = 270°.

Example 1. 3 o'clock to 12 o'clock. Start 3 o'clock. Press **0** . Press for next step.

Input ending angle ED ANG. Ending 12 o'clock. Press **90** **ENT**. Press **↓** for next step.

Select inner or outer arc.

Press **↑** **↓** for select outer arc = *RAD+* or inner arc = *RAD-*.

Example 1 is outer arc. Select *RAD+* Press **ENT**. Press **↓** for next step.

Process.

If start position as 1(a) the display shows X 35.000 and Y 12.500.

If start position as 1(b) the display shows X 0.000 och Y 12.500

Adjust machine table until X and Y axis shows 0.000. Make the first cut. *NO 1*

Press **↓** Adjust machine table until X and Y axis shows 0.000. Make second cut. *NO 2*

Press **↓** Adjust machine table until X and Y axis shows 0.000. Make third cut *NO 3* etc. *OVER* shows on the display when the process is finished.

Example 2

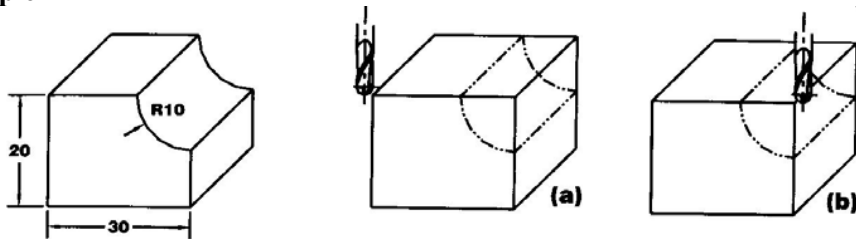

Mount workpiece and tool setting. Zero set each axis. Press **Xo Yo Zo**.

Select Arc function. Press **ARC**. *ARC* shows on the display.

Select plane XZ. Press **↑** **↓**. Confirm with **ENT** Press **↓** for next step.

Input arc center CT Distance from centre of tool position to centre of arc.

The value is different depending if a flat bottom milling tool or arc milling tool is used.

CT for 2 (a) with arc milling tool. X=32,5 Z=-2,5.

Press **X** **32,5** **ENT**. Press **Z** **±** **2,5** **ENT**. Press **↓** for next step.

CT for 2 (a) with flat bottom tool. X=35 Z=0

Press **X** **35** **ENT**. Press **Z** **0** **ENT**. Press **↓** for next step.

CT for 2 (b) with arc milling tool. X=-2,5 Z=-2,5.

Press **X** **±** **2,5** **ENT**. Press **Z** **±** **2,5** **ENT** Press **↓** for next step.

CT for 2 (a) with flat bottom tool. X=0 Z=0

Press **0** . Press **0** . Press for next step.

Input Arc Radius. RADIUS

Radius is 10 mm. Press **10** . Press for next step.

Input diameter of tool. TL DIA.

With arc milling tool is diameter 5 mm. Press **5** . Press for next step.

With flat bottom tool is diameter 0 mm. Press **0** . Press for next step.

Input max cutting MAX CUT.

Select depth for each cut. Example 0.5 mm. Press **0.5** . Press for next step.

Input starting angle ST ANG. See page 4.

Given anti clockwise. 3 o'clock = 0° 12 o'clock = 90° 9 o'clock = 180° 6 o'clock = 270°.

Example 2, from 6 o'clock to 9 o'clock. Start 6 o'clock. Press **270** . Press for next step

Input ending angle ED ANG. Ending 9 o'clock. Press **180** . Press for next step.

Select inner or outer arc.

Press for select outer arc = RAD+ or inner arc = RAD-.

Example 2 is inner arc. RAD-. Press . Press for next step.

Process.

Example 2(a) with arc milling tool the display shows X 32.500 and Z 10.000.

Example 2(b) with arc milling tool the display shows X 2.500 and Z 10.000.

Example 2(a) with flat bottom tool the display shows X 35.000 and Z 10.000.

Example 2(b) with flat bottom tool the display shows X 0.000 and Z 10.000.

Adjust machine table until X and Y axis shows 0.000. Make the first cut. NO 1

Press Adjust machine table until X and Y axis shows 0.000. Make second cut. NO 2

Press Adjust machine table until X and Y axis shows 0.000. Make third cut NO 3 etc.

OVER shows on the display when the process is finished.



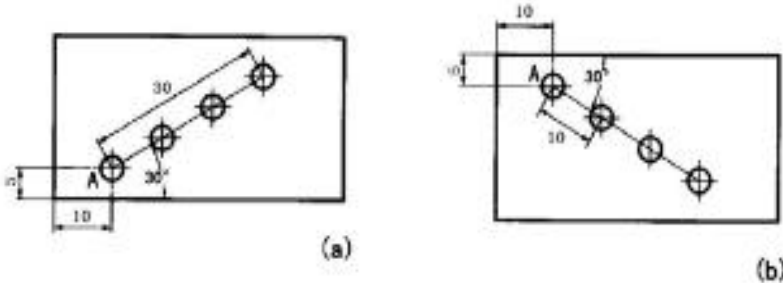

Oblique line function



Mount workpiece and move tool in position of first hole A

Zero set each axis. Press **Xo Yo Zo.**

Select oblique line function. Press . *LINE* shows on the display.

Select plane XY, XZ or YZ. See page 4. Press with   Press  Press  for next step



Select length or step.

Length *Mode L* is distance of starting hole and ending hole. Example (a).

Step *Mode S* is distance between two adjacent hole. Example (b).



Press  . Confirm with  Press  for next step.

Input length. *LENGTH* shows on the display. Example (a) Mode L value is 30 mm.

Example (b) Mode S value is 10 mm. Press value. Press  Press  for next step.

Input angel *ANGEL* shows on the display. Press angel of oblique line.

Example (a) angel is 30°. Example (b) angel is -30°.

Press 30 alternativt -30. Press  Press  for next step.

Input number of holes. *NUMBER* shows on the display. Press number of holes.

Press 4. Press  for next step.

Process.

No1. Adjust machine table until X and Y axis shows 0.000. Make first hole. Press 

No 2. Adjust machine table until X and Y axis shows 0.000. Make second hole. Press 

OVER shows on the display when the process is finished.

Circle holes function

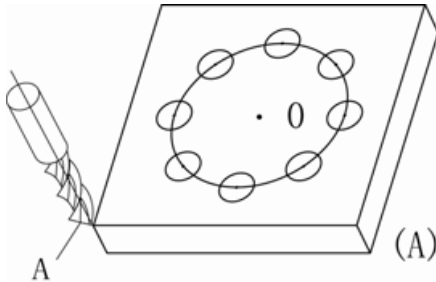

Mount workpiece and move tool in position of first hole A

Zero set each axis. Press **Xo Yo Zo.**

Select circle hole function. Press . *PCD* shows on the display.

Select plane XY, XZ or YZ. See page 4. Press with Press Press

Input central position of circle CT POS. Position from tool A to central of circle 0.

Press and value. Press . Press and value. Press . Press

Input diameter of circle DIA. *DIA* shows on the display. Press value. Press Press for next step

Input number of holes. *NUMBER* shows on the display. Press number. Press Press for next step

Input position of first hole ST ANG. Anger i grader. Se sid 4.

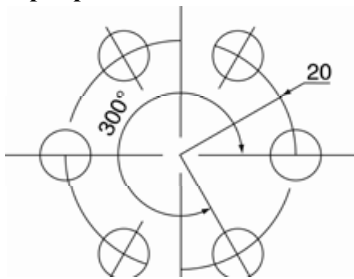

Ex. 6 holes and first hole is 3 0'clock = 0

Press 0. Press Press for next step.

Input position of last hole ED ANG. 300° from first hole. Press 300 Press Alternative can same be made by setting 7 holes. Than is first and last hole in same position.

In that case will ED ANG be 360 instead of 300. Press for next step.





Process. No1. Adjust machine table until X and Y axis shows 0.000. Make first hole.



Press etc. *OVER* shows on the display when the process is finished.





Bevel function





Zero set each axis. Press **Xo Yo Zo.**

Select bevelfunction. Press  *LINE* shows on the display.

Select plane XY, XZ or YZ. See page 4. Press with   Press  Press  for next step

Input diameter of tool. TL DIA. Press value . Press  for next step.

Input start position. ST POT Press  Press x-position. Press . Press  Press z-position. Press . Press  for next step

Input end position. ED POT Press  Press x-position. Press . Press  Press z-position. Press . Press  for next step

Process. No1. Make first cut. Press 

No2. Adjust machine table until X and Y axis shows *0.000*. Make second cut. Press 

No3 Adjust machine table until X and Y axis shows *0.000*. Make second cut. Press 





OVER shows on the display when the process is finished.

Exempel

Mount workpiece and move tool in position

Zero set each axis. Press **Xo Yo Zo.**

Select bevelfunction. Press 

Select plane Plane XZ in example. Press  or 
Press  Press 

Input diameter of tool. TL DIA

Tool diameter is 5 mm. Press **5** Press  Press 

Input start position. ST POT Press  **0** .

Press  **-10** . Press  for next step

Input end position. ED POT Press  **10** . Press  **0** . Press  for next step.

Process. No1. Make first cut. Press  etc.

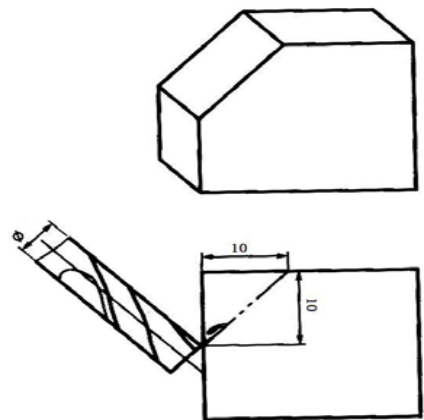



Inner cavity function

Mount workpiece and move tool in position

Zero set each axis. Press **Xo Yo Zo.**

Select inner cavity function. Press  *FLAT* shows on the display

Select plane XY, XZ or YZ. See page 4 Press  or .

Press  Press  for next step

Input diameter of tool. TL DIA

Tool diameter is 5 mm. Press **5** Press  Press  for next step.

Input central position of inner cavity CT.

Position from tool centre to central position of inner cavity

Press  **77.5** . Press  **52.5**  Press  for next step.

Input size of inner cavity. SIZE. The size is 75 x 60 mm.

Press  **75** . Press  **60** . Press  for next step.

Process.

No1. Adjust machine table until X and Y axis shows *0.000*. Make first hole. Press 

No 2. Adjust machine table until X and Y axis shows *0.000*. Make second hole. Press 

OVER shows on the display when the process is finished.

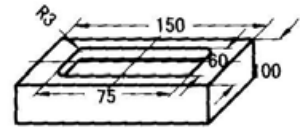

(1)

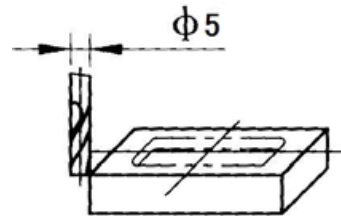

(2)

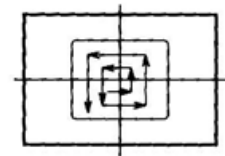

(3)

Tool compensating function

To process part with four sides .

Mount workpiece and set tool in position as (2) or (3)



Zero set each axis. Press **Xo Yo Zo.**

Select tool compensating function.

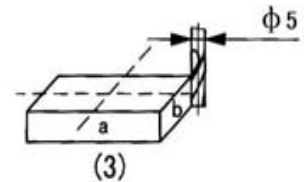
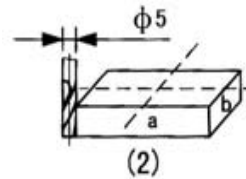
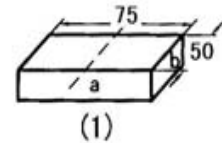
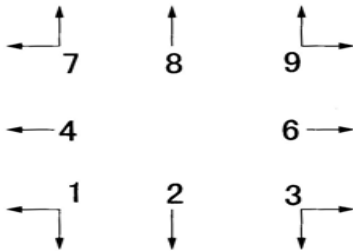

Press  WHICH shows on the display.

Select any of 8 processing models.



Example (2) Press **9**. Press  Example (3) Press **1** Press  press  for next step.

Input diameter of tool. TL DIA

Tool diameter is 5 mm. Press **5** Press  Press  for next step.

Process

Example (2). Move machine table until display shows *X 75.000* and *Y 50.000*

Example (3). Move machine table until display shows *X -75.000* and *Y - 50.000*.

The process can be repeated for the two remaining sides.